



## Overview

The RS-232 Serial Box is a data interface radio transceiver which can be connected to any system that uses an RS-232 serial port. The device communicates with ILLUMRA wireless switches, sensors, and receivers and allows other systems to communicate with ILLUMRA wireless controls.

### Compatible Devices

- Single Rocker Self-powered Wireless Light Switch; E3T-S1Axx
- Dual Rocker Self-powered Wireless Light Switch; E3T-S2Axx
- Handheld Self-powered Wireless Light Switch; E3T-S2Hxx
- Key Card Access Switch; E3T-C1AWH
- SLT Wireless Sensor; E3T-Rxx-2INBP
- Self-powered Wireless Occupancy Sensor; E3T-Mxx-SB24
- More compatible devices available

### Components Included

The following items are included with this product:

- A -- (1) ILLUMRA RS-232 Serial Box

## Installation

The RF Serial Box can be mounted almost anywhere. The following considerations should be taken into account:

- Mount within range of wireless switches and receivers; obstructions limit range (see specifications)
- Mount in area where power source is available (see specifications)
- Do not exceed max RS-232 cable length
- For optimal range:
  - Do not mount or place RF Serial box close to the floor
  - Do not mount or place RF Serial box inside a metal housing

## Connections (Interfacing Protocol)

The RF Serial Box can accept external power through either the power connector, or through pin 9 of the DB9 port. When using an external power source, connect to the power jack using the provided screw terminals. The power connector accepts 8-28 VAC or 8-30 VDC. The power connector is polarity insensitive, but power provided through the DB9 port must be DC, not AC, and connected with correct polarity (+ to Pin 9, - to GND).

A standard DB-9 female connector is provided on the device. It may be necessary to connect the Serial Box to the security/control/automation panel using a null-modem cable, but connection to a PC requires a standard straight-through cable.

Figure A: RS-232 (DB-9) Serial Port Pin Signals

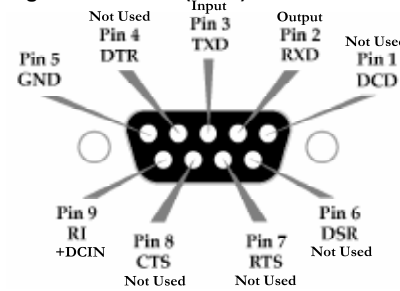

## Packet Structure

### Message Format

Figure B shows the message format. A data block of length n is composed of 2 synchronization bytes, 1 octet for the header and n-1 octets for the message data.

Figure B: Message Format for Asynchronous Serial Communication

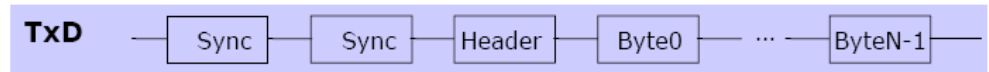

### Octet Signals and Bit Order

- 9600 bps; 8 data bits, no parity bit, one start bit, one stop bit
- Line idle is binary 1 (standard)
- Each character has one start bit (binary 0), 8 information bits (least significant bit first) and one stop bit (binary 1)
- The signal levels shown in the timing diagram are inverted from the voltages that appear on the RS232 connector.

Figure C: Octet Signals and Bit Order

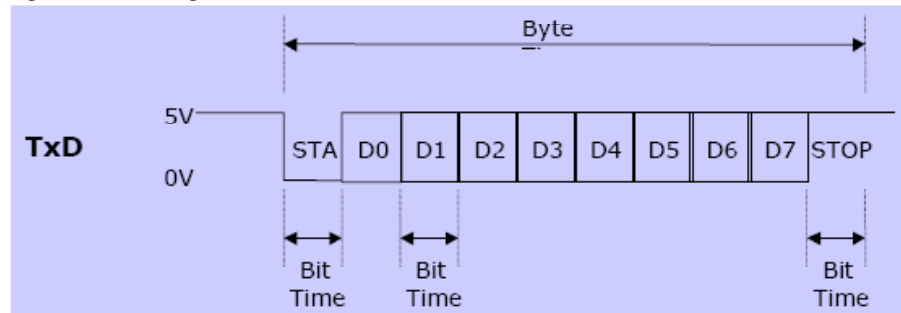

## Serial Data Structure

The structure of the serial data is as follows:

**Table A: Serial Data Structure**

Bit 7	Bit 0
SYNC_BYTE1 (A5 Hex)	
SYNC_BYTE0 (5A Hex)	
H_SEQ (3 bits)	LENGTH (5 bits)
ORG	
DATA_BYTE3	
DATA_BYTE2	
DATA_BYTE1	
DATA_BYTE0	
ID_BYTE3	
ID_BYTE2	
ID_BYTE1	
ID_BYTE0	
STATUS	
CHECKSUM	

SYNC\_BYTE 0..1 (8 bit each) Synchronization Bytes

H\_SEQ (3 bit) Header Identification [refer to table below]

**Table B: Header Identification**

H_SEQ	Meaning	Mode
0b 000	Unknown transmitter ID received (serial telegram only if no ID has been learned so far!) For RPS also: -- Known transmitter ID and unknown rocker -- U-message from known transmitter ID received For HRC also: -- Known transmitter ID and unknown rocker -- Scene switch command (last three bits of ID 0b111) from known transmitter ID (only first 29 bits are compared!)	Operating Mode
0b 001	For 1BS and 4BS: Known transmitter ID received For RPS: Known transmitter ID and at least 1 known rocker (1 or 2 rockers operated) For HRC: Known transmitter ID and known rocker	Operating Mode
0b 010	New transmitter learned (If a switch telegram is received (RPS or HRC), the rocker code (RID) is stored together with the ID.) • Mode 3: a telegram with this header information will be sent also when in LRN mode a transmitter which is already learned is operated again	Learn Mode
0b 110	Mode 0: Transmitter just deleted (If a switch telegram is received (RPS or HRC), the rocker code (RID) and module ID are checked. The entry is only deleted if module ID and rocker are known.)	Learn Mode

LENGTH	(5 bit)	Number of octets following the header octet (11 dec)
ORG	(8 bit)	Type of telegram (see detail description)
DATA_BYTE 0..3	(8 bit each)	Data bytes 0..3 (see detail description)
ID_BYTE 0..3	(8 bit each)	32-bit transmitter ID
STATUS	(8 bit)	Status field (see detail description)
CHECKSUM	(8 bit)	Checksum (Last LSB from addition of all octets except sync bytes and checksum)

**Table C: Detailed Description of ORG Field**

ORG field value (decimal)	Acronym	Description
5	RPS	Telegram from a PTM switch module received (e.g. PTM 100 or PTM 200)
6	1BS	1 byte data telegram from a STM sensor module (e.g. STM 250)
7	4BS	4 byte data telegram from a STM sensor module (e.g. STM 100)
8	HRC	Telegram from a CTM module received
0-47, 9-255	--	Reserved

## Operation

Verify Serial Port – Connect to terminal program, like “HyperTerminal” or “Portmon” and monitor activity on serial port. Each time another ILLUMRA device transmits, a few copies of the data packet should flow through to the serial port.

The data received from the modules contains non-printable characters. In order to see the exact contents of the received packets, set up a text capture with Transfer->Capture Text. An alternative to the text capture method is to run a serial port monitoring program (use Google to search for “portmon” which is available as a free download from microsoft.com, and can display the hexadecimal values during serial operation).

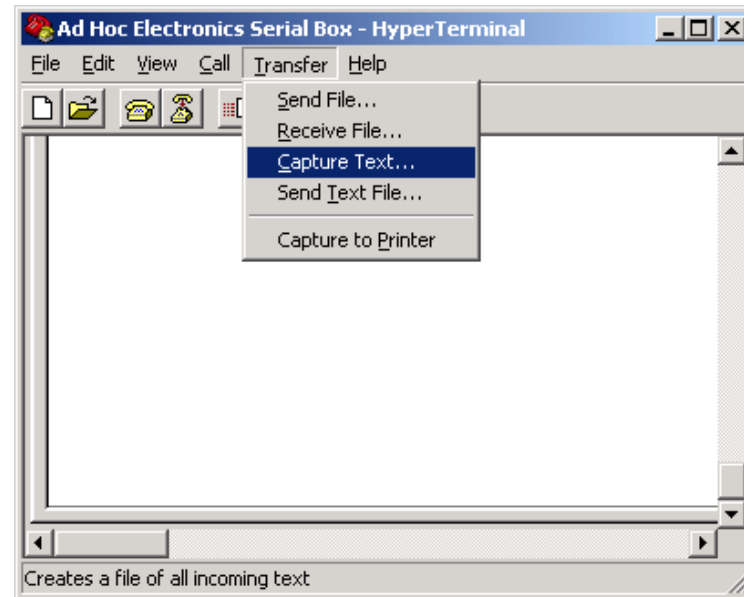

Save the file in a convenient location.

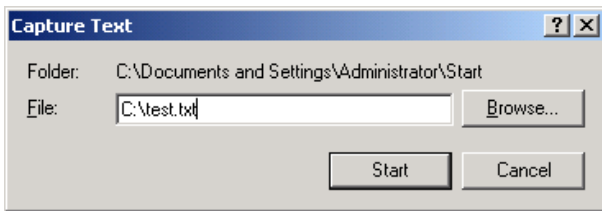

Press a switch button and two packets of 14 bytes each will be received and displayed. If a repeater is in range, two copies of each packet will be received, the later of which will contain a bit indicating that the packet has been repeated.

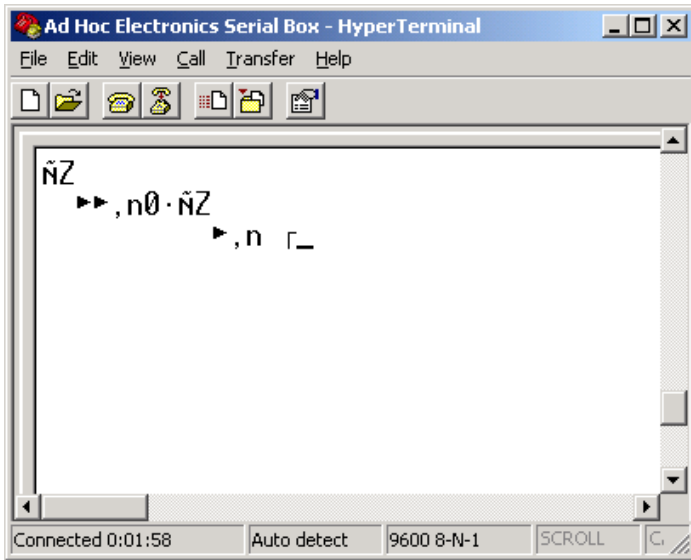

In order to view the actual contents of the data packet, stop the text capture process by selecting Transfer->Capture Text->Stop. This step is important, as it closes the file so it can be read by other programs. Now download a hex editor program. A free one called XVI32 is available on the web.

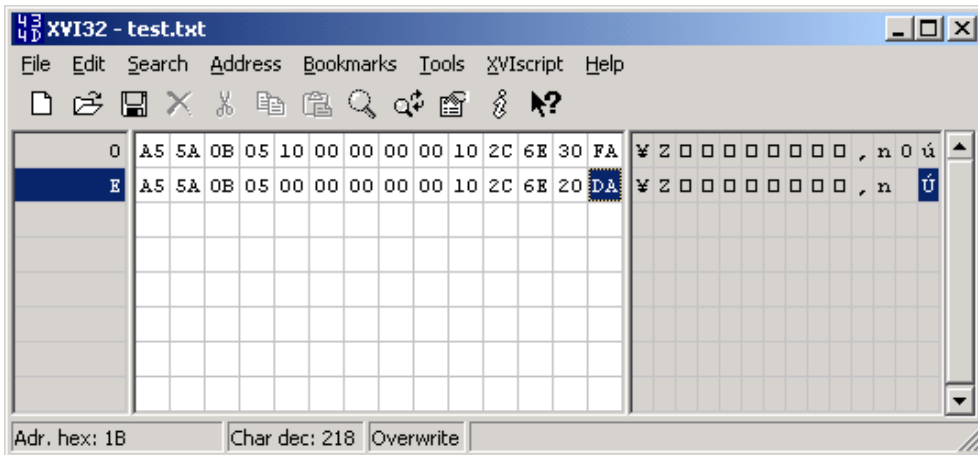

Use the hex editor to open the captured text file, and the full packet is visible in hexadecimal format. Note in the packets shown, the 5th byte indicates the state of one of the buttons on the PTM module. Note that the button was pressed for the first packet, (0x10) and released for the second packet (0x00). This is the sequence received when a user presses and releases the button on a battery-free wireless switch.

## Specifications

	E3X-232FP
<b>Range</b>	50-150 feet (typical)
<b>Frequency</b>	315 MHz
<b>Power Supply Input Rating</b>	8-28 VAC or 8-30 VDC
<b>Current</b>	25mA @ 12 VDC, 15mA @ 24 VDC
<b>Operating Temperature</b>	-13° to +140°F (-25° to +60°C)
<b>Storage Temperature</b>	-40° to +140°F (-40° to +60°C)
<b>Dimensions</b>	5.12"W x 3.21"H x 1.10"D 10.7cm x 7.2cm x 2.9cm
<b>Serial Port Settings</b>	9600 baud, 8 bits, No parity, 1 stop bit
<b>Radio Certification</b>	FCC (United States): SZV-TCM2XXC I.C. (Canada): 5713A-TCM2XXC



Contains FCC ID: SZV-TCM2XXC

Contains IC: 5713A-TCM2XXC

The enclosed device complies with Part 15 of the FCC Rules. Operation is subject to the following two conditions: (i.) this device may not cause harmful interference and (ii.) this device must accept any interference received, including interference that may cause undesired operation.

This device or certain aspects thereof is protected by at least one U.S. or international patent or has at least one such patent application pending.



ILLUMRA is a trademark of Ad Hoc Electronics, LLC. Other trademarks herein are the property of their respective owners.